

EVENING FYRE & EVENING FYRE CHARRED LOG PLACEMENT INSTRUCTIONS

CAUTION.....WARNING.....IMPORTANT

USE ONLY A PETERSON REAL FYRE G18 BURNER WITH THIS REAL FYRE LOG SET.



EFV-24 shown



LOG SET IMPORTANT INFORMATION

This instruction contains log set placement for these Real Fyre logs. You must position and maintain the log layout as shown here to ensure proper operation of the burner system. Incorrect log installation could cause flame impingement and improper combustion, resulting in soot and/or excessive by-products of combustion. **DO NOT** add any additional embers for this installation. Any additional embers will cause unsafe operation. **Use these logs only with a Peterson G18 burner system.**

If you experience an accumulation of black carbon (soot) on your logs it is an indication of incomplete combustion and you must correct the log placement as instructed in this manual. If significant sooting continues, stop using this gas log set.

Please read these instructions completely and carefully.

Important: Adequate spacing between the logs is **NECESSARY** and **MUST** be maintained. If carbon build up (sooting) exists, correct log placement before sooting becomes worse. **If any sooting occurs outside of the firebox (i.e. on the walls), turn off unit immediately and contact a qualified professional service technician.**

WARNING: Use **ONLY** a Peterson Real Fyre G18 burner with this Real Fyre gas log set. **Failure to do so may result in property damage or personal injury, and will void listings, certifications, and invalidate claims made to RHP.** Contact your local Real Fyre dealer if you need more information.

This product is only warranted when used as part of a Robert H. Peterson Co. unvented burner system.

WARNING: This gas log set is for use with an R.H. Peterson Co. G18 burner (and parts) ONLY.

CAUTION: Burn hazard! Logs will remain hot for some time after use.
If you need to reposition any log to maintain the proper layout, use heat resistant gloves or allow logs adequate time to cool before handling.

Failure to use a Peterson G18 burner may result in a **DANGEROUS** situation and in property damage, personal injury or even death, will void listings and certifications, and will void any insurance coverage by R.H. Peterson Co. or our insurers.

EVENING FYRE & EVENING FYRE CHARRED LOG PLACEMENT INSTRUCTIONS (16/18" MODEL)

The underside of the bottom logs have cutouts and tabs that align over the burner. **THE BOTTOM LOGS MUST BE FULLY SEATED ON THE BURNER.** Certain logs have notches on them to allow for the logs to interlock in place.

E(F,C)V-16/18 PARTS LIST



CAUTION: Burn hazard! Logs will remain hot for some time after use.

All items for this log set are included in one (1) box.

I

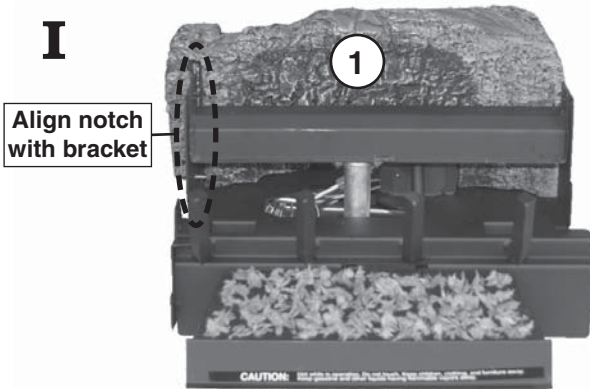

Place the rear log (log #1) as shown. Slide it forward on the burner, against the main burner bracket. **ENSURE THE LOG RESTS FLAT ON THE BURNER, AND THAT THE LEFT BURNER BRACKET ALIGNS WITH THE GROOVE FOUND ON THE FACE OF THE LOG.**

II

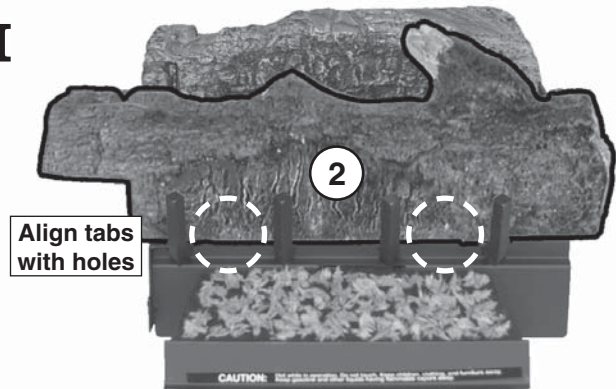

Place the front log (log #2) as shown. The underside of the log has two tabs that insert into the holes found on the burner. **ENSURE THE LOG RESTS FLAT ON THE BURNER.**

III

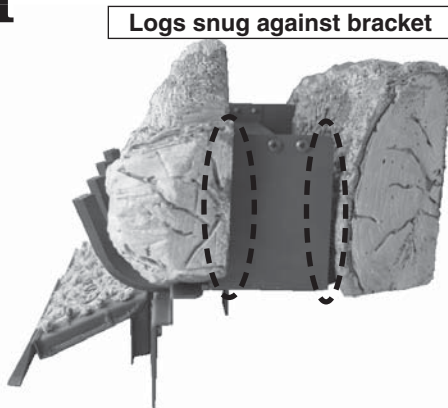

Ensure the rear and front logs are snug up against the main burner bracket.

IV



Place the left top log (log #3) as shown. The log should lock in place over the logs below.

V

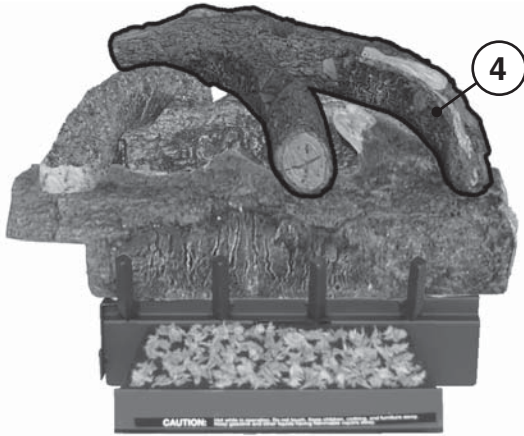

Place the right top log (log #4) as shown. The log should lock in place over the logs below.

VI

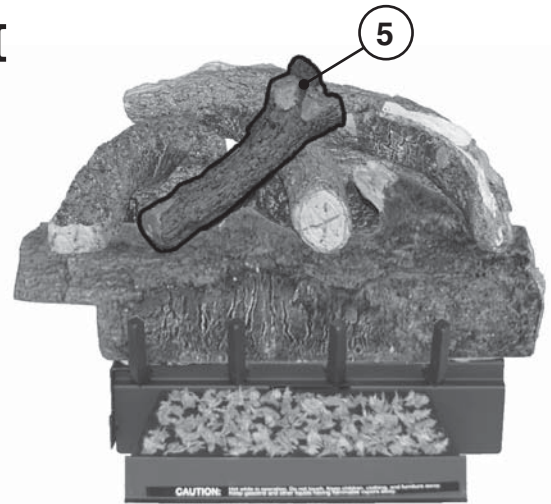

Place the center top log (log #5) as shown. The log should lock in place over the logs below.

VII

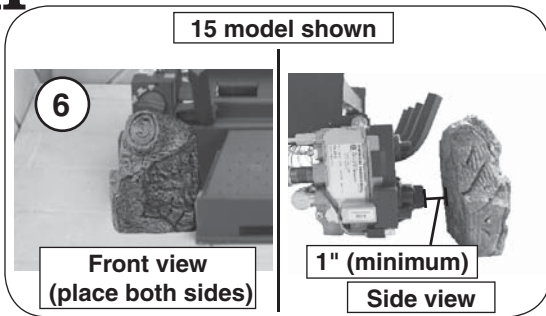

Place the decorative wood chips in front of the burner. Ensure the charred ends face inward. For the wood chip in front of the valve, ensure at least 1" between it and the valve.

CAUTION: Ensure the wood chip in front of the valve is at least 1" away from the valve to avoid overheating and damage to the valve. If this minimum requirement of 1" clearance is not possible, DO NOT use the wood chip.

CAUTION: THE WOOD CHIPS WILL BE HOT DURING AND AFTER OPERATION.

VIII



Final Log Placement

After setting the logs into position as described above, ensure each is properly and firmly seated. The vent-free gas log set will not function as intended if the logs are not correctly positioned. When placed properly, the flames will not strike any portion of the logs. Periodically check the positioning of all logs to ensure proper log placement and stability. If any flame is striking the logs, recheck log placement. Adjust to conform with instructions. **There should be no flame impingement on the logs.**

EVENING FYRE & EVENING FYRE CHARRED LOG PLACEMENT INSTRUCTIONS (24" & 30" MODELS)

The underside of the bottom logs have cutouts and tabs that align over the burner. **THE BOTTOM LOGS MUST BE FULLY SEATED ON THE BURNER.** Certain logs have notches on them to allow for the logs to interlock in place.

E(F,C)V-24 & E(F,C)V-30 PARTS LIST

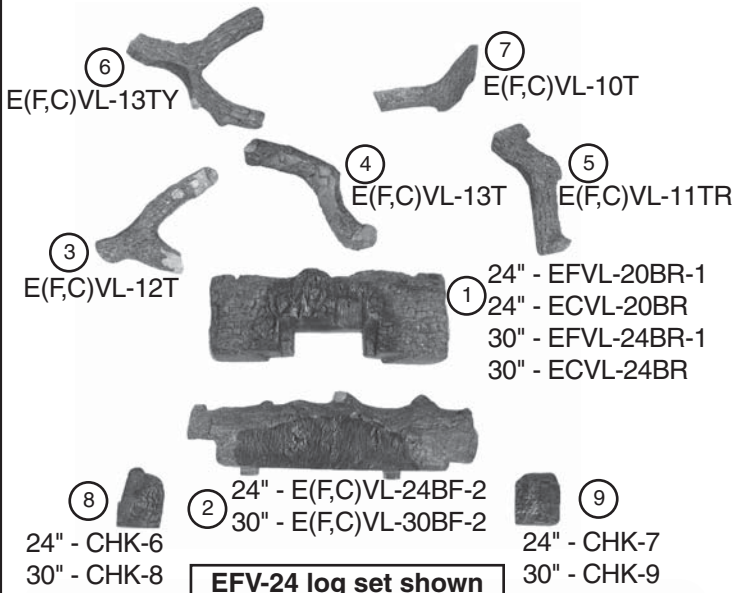

CAUTION: Burn hazard! Logs will remain hot for some time after use.

All items for this log set are included in one (1) box.

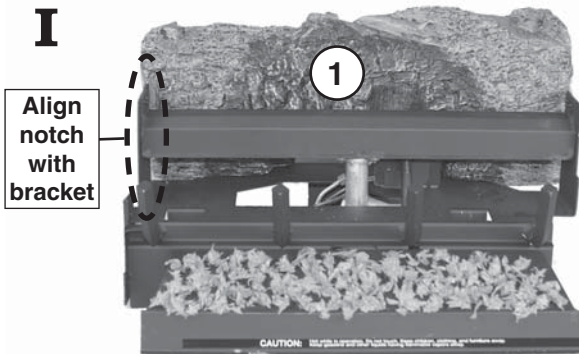

Place the rear log (log #1) as shown. Slide it forward on the burner, against the main burner bracket. ENSURE THE LOG RESTS FLAT ON THE BURNER, AND THAT THE LEFT BURNER BRACKET ALIGNS WITH THE GROOVE FOUND ON THE FACE OF THE LOG.

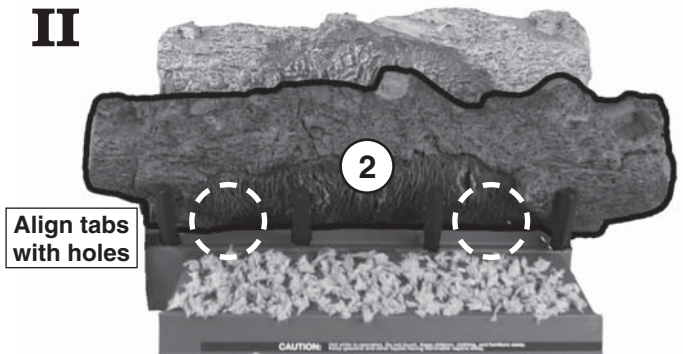

Place the front log (log #2) as shown. The underside of the log has two tabs that insert into the holes found on the burner. ENSURE THE LOG RESTS FLAT ON THE BURNER.

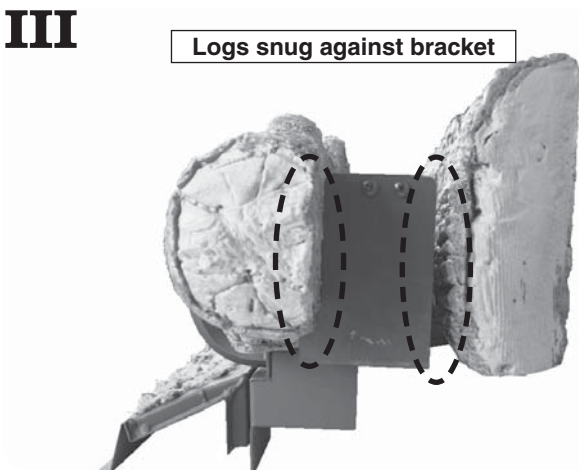

Ensure the rear and front logs are snug up against the main burner bracket.

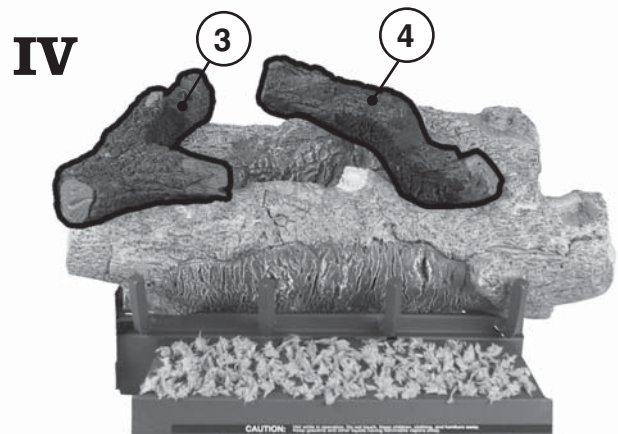

Place the left middle log (log #3) as shown. The log should lock in place over the logs below.

Place the center middle log (log #4) as shown. The log should lock in place over the logs below.

V

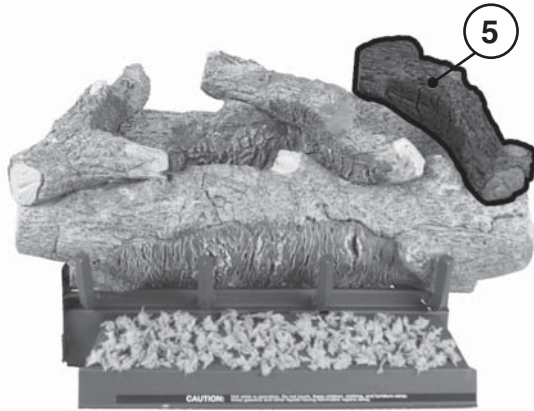

Place the right middle log (log #5) as shown. The log should lock in place over the logs below.

VI

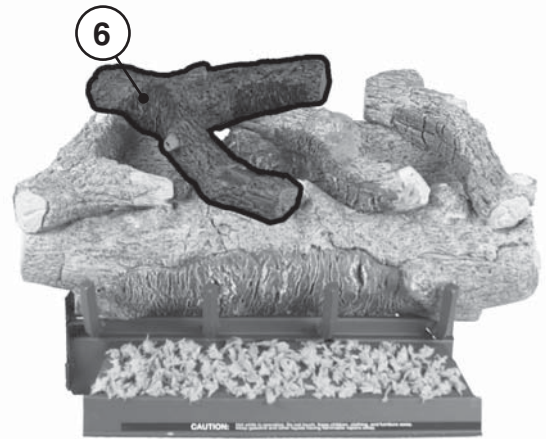

Place the left top log (log #6) as shown. The log should lock in place over the logs below.

VII

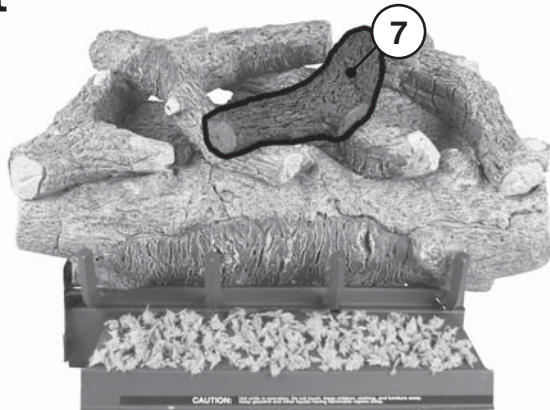

Place the center top log (log #7) as shown. The log should lock in place over the logs below.

VIII

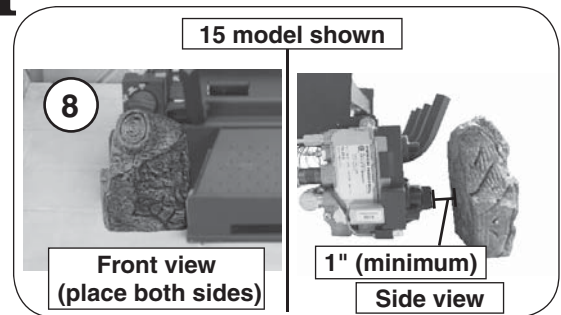

Place the decorative wood chips in front of the burner. Ensure the charred ends face inward. For the wood chip in front of the valve, ensure at least 1" between it and the valve.

CAUTION: Ensure the wood chip in front of the valve is at least 1" away from the valve to avoid overheating and damage to the valve. If this minimum requirement of 1" clearance is not possible, DO NOT use the wood chip.

CAUTION: THE WOOD CHIPS WILL BE HOT DURING AND AFTER OPERATION.

IX



Final Log Placement

After setting the logs into position as described above, ensure each is properly and firmly seated. The vent-free gas log set will not function as intended if the logs are not correctly positioned. When placed properly, the flames will not strike any portion of the logs. Periodically check the positioning of all logs to ensure proper log placement and stability. If any flame is striking the logs, recheck log placement. Adjust to conform with instructions. **There should be no flame impingement on the logs.**