



Please consult the manufacturer's installation manual for all details and requirements before making a final design layout decision.

30" Electric Fireplace Insert

| MODEL | WATTS | FRONT WIDTH A | BACK WIDTH B | HEIGHT C | DEPTH D | STANDARD FRONT E x F | VIEWING AREA G x H |
|----------|-------|---------------|---------------|---------------|---------------|---------------------------|---------------------------|
| SF-INS30 | 1,500 | 29-7/8" [758] | 22-7/8" [581] | 20-1/2" [521] | 11-1/4" [286] | 33" x 21-3/4" [838 x 552] | 27" x 16-1/4" [686 x 413] |

FRONT VIEW

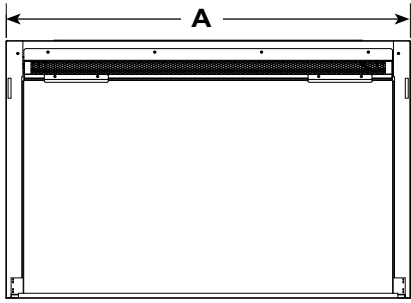

STANDARD FRONT

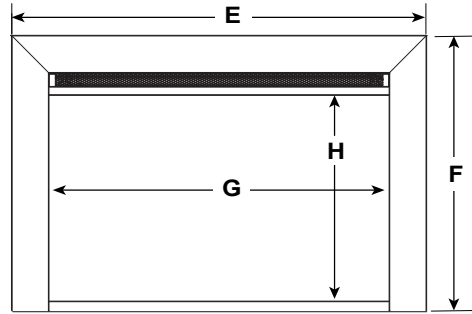

TOP VIEW

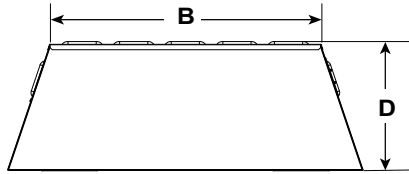

SIDE VIEW

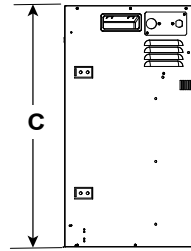

| FRAMING WIDTH A | FRAMING HEIGHT B | FRAMING DEPTH C | FRAMING WIDTH D | FRAMING DEPTH E | FRAMING DEPTH F |
|-----------------|------------------|-----------------|-----------------|-----------------|-----------------|
| 30-3/8" [772] | 20-5/8" [524] | 11-3/8" [289] | 44-1/4" [1124] | 31-1/2" [800] | 22-3/8" [568] |

TOP VIEW

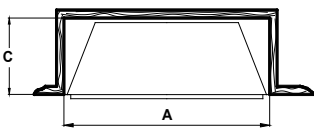

FRONT VIEW

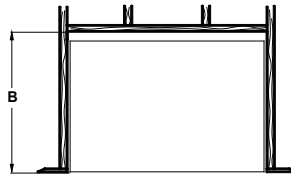

CORNER VIEW

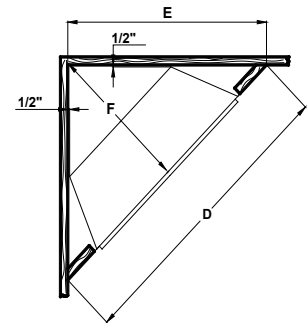

ELECTRICAL CONNECTION REQUIREMENTS

| CIRCUIT | CONNECTION METHOD | BTUS |
|--------------------|---------------------|-------|
| 15 AMP, 120V/60 Hz | Hardwire or plug-in | 5,000 |

| PRODUCT LISTING CODES | |
|-----------------------|----------------------|
| US | CSA 22.2 No 46-M1988 |
| INTERNATIONAL | CSA 22.2 No 46-M1988 |

Product information provided is not complete and is subject to change without notice. Product installation must adhere strictly to instructions accompanying product to avoid risk of fire and potential injury.



Additional information can be found online at www.simplifire.com



Lakeville, MN
Phone: 888-427-3973 952-985-6000